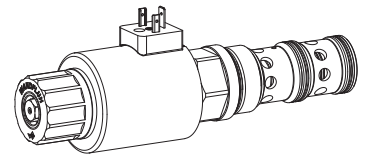

**Proportional 3-way flow control valve
Screw-in cartridge**

- Direct operated, pressure compensated
- $Q_{max} = 200 \text{ l/min}$, $p_{max} = 350 \text{ bar}$
- $Q_{Nmax} = 160 \text{ l/min}$

M42 x 2
 ISO 7789

DESCRIPTION

Direct operated, pressure compensated proportional flow control valve as a screw-in cartridge with a thread M42x2 for cavity acc. to ISO 7789. The volume flow is adjusted by a Wandfluh proportional solenoid (VDE standard 0580). The cartridge body is made of steel. A special surface treatment guarantees a good protection against corrosion and wear as well as very good low-friction characteristics of the pressure compensating- and throttle spool. The solenoid coil is zinc- / nickel-coated.

FUNCTION

The 3-way flow control valve serves for maintaining the speed of a consumer constant independent of the load. Superfluous pump output flow is fed into the return flow system in a cost saving manner, and as a result, prevents an overheating of the hydraulic system. The power controlled, proportional solenoid running in oil acts directly on the throttle spool, which opens the throttle segments in the cartridge body. Proportional to the current demand of the proportional solenoid, the throttle aperture changes, and with this the volume flow. In case of a current-free solenoid, the throttle spool is held in closed position by a spring. For driving the valve, Wandfluh proportional amplifiers are available (see Register 1.13).

APPLICATION

Proportional flow control valves are suitable for feed control systems, where the consumer flow has to be maintained constant with a changing load. The screw-in cartridge is suitable for installation in control blocs.

TYPE CODE

		Q D P PM42- 160 - <input type="checkbox"/> / W <input type="checkbox"/> - <input type="checkbox"/> <input type="checkbox"/> # <input type="checkbox"/>	
Flow control valve			
3-way			
Proportional			
Screw-in cartridge M42x2			
Nominal volume flow rate Q_N	160 l/min		
Nominal voltage U_N	12 VDC	<input type="checkbox"/> G12	
	24 VDC	<input type="checkbox"/> G24	
	without coil	<input type="checkbox"/> X5	
Slip-on coil	Metal housing, round		
Connection execution	Connector socket EN 175301-803 / ISO 4400	<input type="checkbox"/> D	
	Connector socket AMP Junior-Timer	<input type="checkbox"/> J	
	Connector Deutsch DT04-2P	<input type="checkbox"/> G	
Sealing material	NBR	<input type="checkbox"/>	
	FKM (Viton)	<input type="checkbox"/> D1	
Manual override	Screwed sealing plug	<input type="checkbox"/> HB0	
	Manual emergency actuation	<input type="checkbox"/> HC8.5	
Design-Index (Subject to change)			

SYMBOLS

simplified

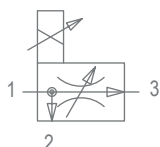

detailed

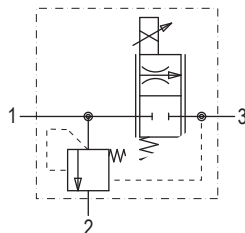
GENERAL SPECIFICATIONS

Description	3-way proportional flow control valve
Construction	Screw-in cartridge for cavity acc. to ISO 7789
Operation	Proportional solenoid
Mounting	Screw-in thread M42x2
Ambient temperature	-20...70 °C
Mounting position	any
Fastening torque	$M_D = 100 \text{ Nm}$ for screw-in cartridge
	$M_D = 5 \text{ Nm}$ for knurled nut
Weight	$m = 2,34 \text{ kg}$
Flow direction	see symbol

ELECTRICAL SPECIFICATIONS

Construction	Proportional solenoid, wet pin push type, pressure tight	
Standard nominal voltage	U = 12 VDC	U = 24 VDC
Limiting current	I _G = 2255 mA	I _G = 1105 mA
Relative duty factor	100 % ED/DF (see data sheet 1.1-430)	
Protection class acc. to EN 60 529	Connection version D: IP65 J: IP66 G: IP67 and 69K	

For further electrical specifications see data sheet 1.1-191

HYDRAULIC SPECIFICATIONS

Fluid	Mineral oil, other fluid on request
Contamination efficiency	ISO 4406:1999, class 18/16/13 (Required filtration grade $\beta_{6...10} \geq 75$) see data sheet 1.0-50/2
Viscosity range	12 mm ² /s...320 mm ² /s
Fluid temperature	-20...+70 °C
Peak pressure	p _{max} = 350 bar
Nominal volume flow rates	Q _N = 160 l/min
Max. volume flow	Q _{max} = 200 l/min (1 → 2)
Min. volume flow	Q _{min} = 0,5 l/min
Hysteresis	≤ 6% * * at optimal dither signal

CHARACTERISTICS Oil viscosity $\nu = 30 \text{ mm}^2/\text{s}$

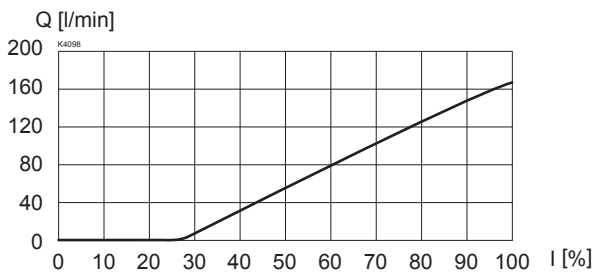
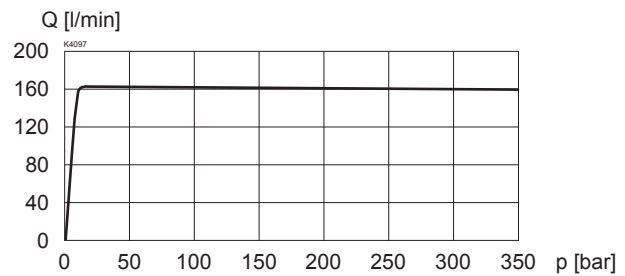
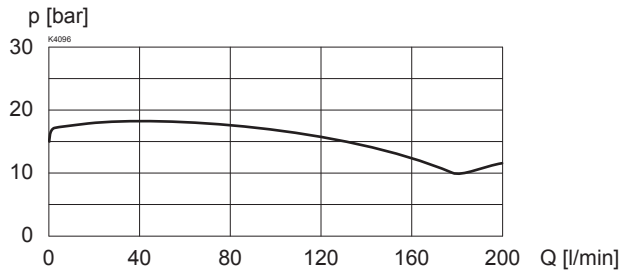
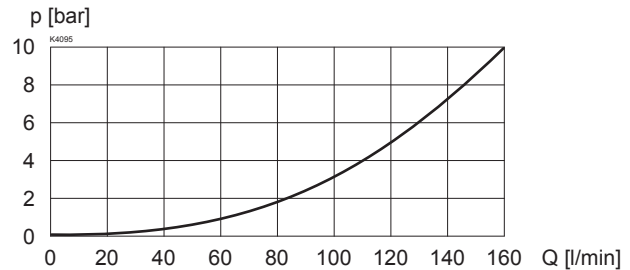
 Q = f (I) Volume flow signal characteristics (p₃ = 100 bar)

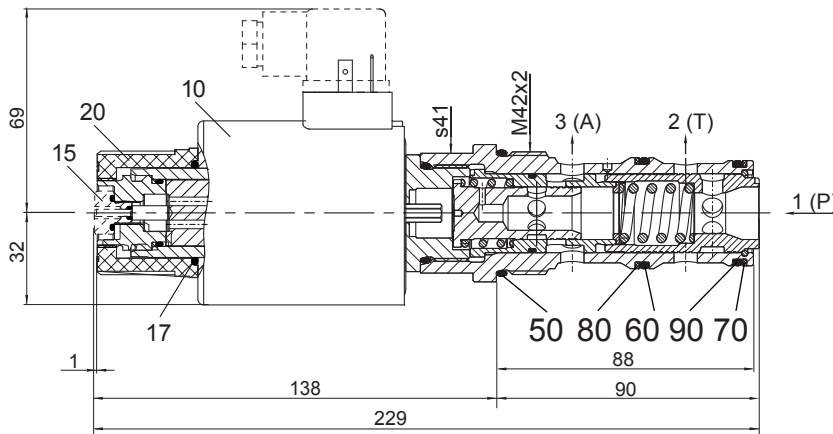
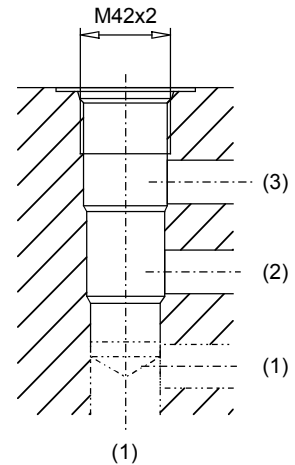
 Q = f (p) Volume flow pressure characteristics (I = I_G)

 $\Delta p = f(Q)$ Pressure drop-volume flow characteristics 1 → 2 (I = 0 mA)

 $\Delta p = f(Q)$ Pressure drop-volume flow characteristics 1 → 3 (I = I_G)

DIMENSIONS / SECTIONAL DRAWINGS

 Cavity drawing acc. to
 ISO 7789-42-04-0-07

Dimensions of the other connection versions see data sheet 1.1-190

 For detailed cavity drawing see data sheet
 2.13-1047

PARTS LIST

Position	Article	Description
10	206.3212	EN 175301 Solenoid coil WDE64/31 x 72-G12
	206.3213	Solenoid coil WDE64/31 x 72-G24
		Junior-Timer
	206.3214	Solenoid coil WJE64/31 x 72-G12
	206.3215	Solenoid coil WJE64/31 x 72-G24
		Deutsch
	206.3216	Solenoid coil WGE64/31 x 72-G12
	206.3217	Solenoid coil WGE64/31 x 72-G24
15	253.8022	HC 8,5 anual override (data sheet 1.1-300)
	239.2033	HB 0 Plug screw (data sheet 1.1-300)
17	160.2282	O-ring ID 28,24 x 2,62 (NBR)
20	154.2706	Knurled nut
50	160.2377	O-ring ID 37,77 x 2,62 (NBR)
	160.8378	O-ring ID 37,77 x 2,62 (FKM)
60	160.2329	O-ring ID 32,99 x 2,62 (NBR)
	160.6325	O-ring ID 32,99 x 2,62 (FKM)
70	160.2314	O-ring ID 31,42 x 2,62 (NBR)
	160.6315	O-ring ID 31,42 x 2,62 (FKM)
80	049.3384	Backup ring RD 33,5x38 x 1,4
90	049.3364	Backup ring RD 31,5x36 x 1,4

ACCESSORIES

 Line mount body Data sheet 2.9-210
 Proportional amplifier Register 1.13
 Mating connector EN 175301-803 Article no. 219.2002

Technical explanation see data sheet 1.0-100