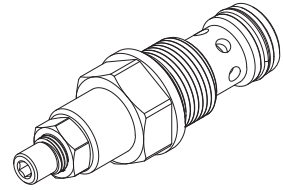

**Throttle valve**
**Screw-in cartridge**

- $Q_{N \max} = 60 \text{ l/min}$
- $Q_{\max} = 80 \text{ l/min}$
- $p_{\max} = 350 \text{ bar}$

**M22x1,5**  
 ISO 7789

**DESCRIPTION**

Manually adjustable, M22x1,5 screw-in cartridge throttle valve in accordance with cavity ISO 7789. The cartridge body made of steel is galvanized and therefore rust-protected.

**FUNCTION**

A fine tread on the adjustable throttle reveals an annular gap. The adjusted throttle cross-section produces a pressure drop which determines the volume flow. The volume flow is zero when the throttle is screwed in (the metal sealing edge seals completely). The valve flow is bidirectional.

**APPLICATION**

Throttle valves can be used anywhere where volume flows can be infinitely controlled in both directions without taking pressure fluctuations into account. Stepped tools are available for making the receptacle bores in steel and aluminium (hire or purchase). Please refer to the data sheets in register 2.13.

**TYPE CODE**

	DN	I	PM22	-	60	#	<input type="checkbox"/>
Throttle valve							
Type of adjustment							
Screw-in cartridge M22x1,5							
Nominal volume flow rate $Q_N$	60 l/min						
Design-Index (Subject to change)							

**GENERAL SPECIFICATIONS**

Description	Throttle valve
Construction	Screw-in cartridge for cavity acc. to ISO 7789
Mounting	Screw-in thread M22x1,5
Ambient temperature	-20...+50 °C
Mounting position	any
Fastening torque	$M_D = 50 \text{ Nm}$
Weight	$m = 0,16 \text{ kg}$
Volume flow direction	1 ↔ 2

**HYDRAULIC SPECIFICATIONS**

Fluid	Mineral oil, other fluid on request
Contamination efficiency	ISO 4406:1999, class 20/18/14...21/19/15
	Required filtration grade ( $\beta_{10...25} \geq 75$ ) (refer to data sheet 1.0-50/2)
Viscosity range	12mm <sup>2</sup> /s...320mm <sup>2</sup> /s
Fluid temperature	-20...+70 °C
Peak pressure	$p_{\max} = 350 \text{ bar}$
Nominal volume flow rates	$Q_N = 60 \text{ l/min}$
	$Q_N$ at 10 bar valve pressure loss
Max. volume flow	$Q_{\max} = 80 \text{ l/min}$
Leakage volume flow	Almost leak free with closed restrictor

**SYMBOL**

**MECHANICAL ACTUATION**

Screw adjustment	with fork wrench and Allen key
Control stroke $S_b$	= 4,5 mm
Control angle $\alpha_b$	= 1620° / 4,5 turns

**CHARACTERISTICS** Oil viscosity  $\nu = 30 \text{ mm}^2/\text{s}$

$\Delta p = f(Q)$  Pressure drop/flow characteristics

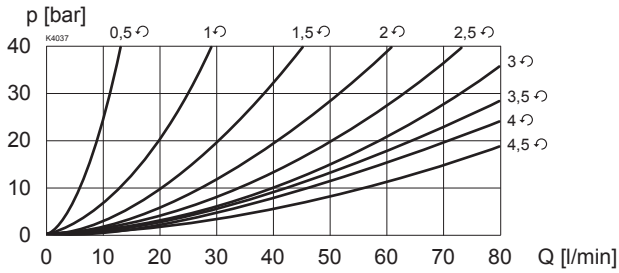

**DIMENSIONS**

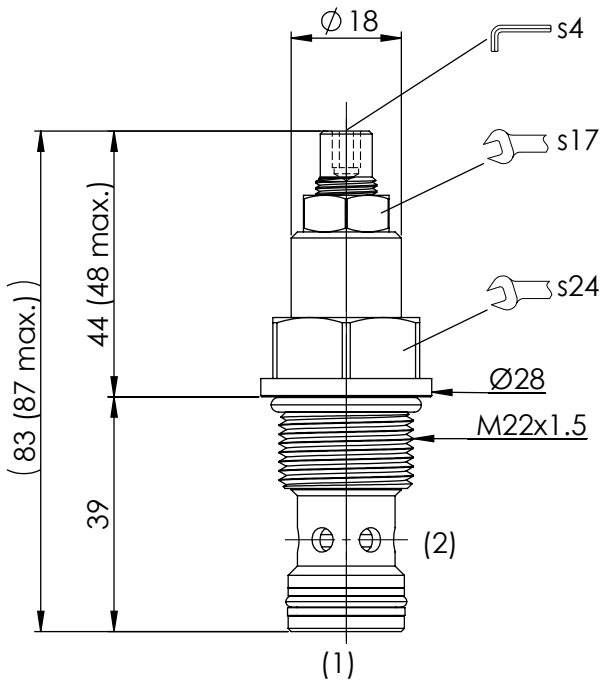

Cavity drawing according to ISO 7789-22-01-0-98

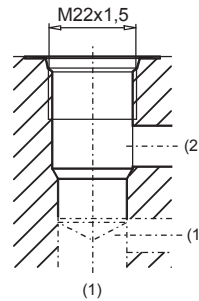

For detailed cavity drawing and cavity tools see data sheet 2.13-1008.

**ACCESSORIES**

Line mount body

Data sheet 2.9-205

Technical explanation see data sheet 1.0-100